

# Dell PH45W17-BA Hybrid Adapter+Power Bank

## Quick Start Guide

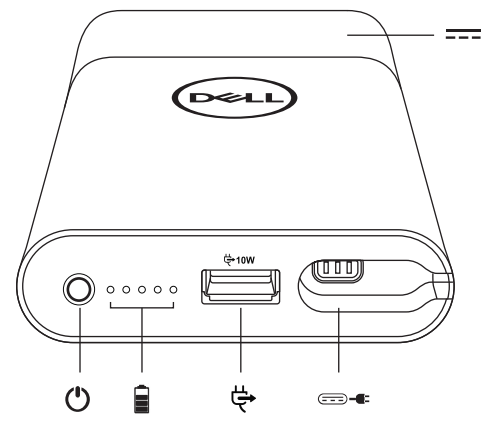

1

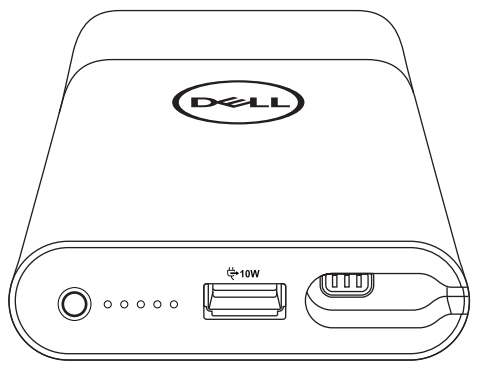
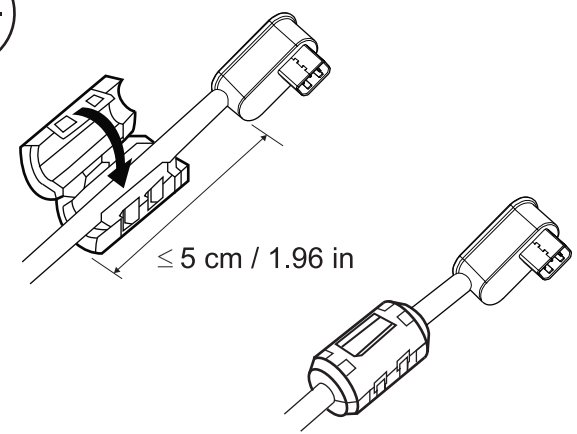
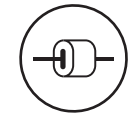
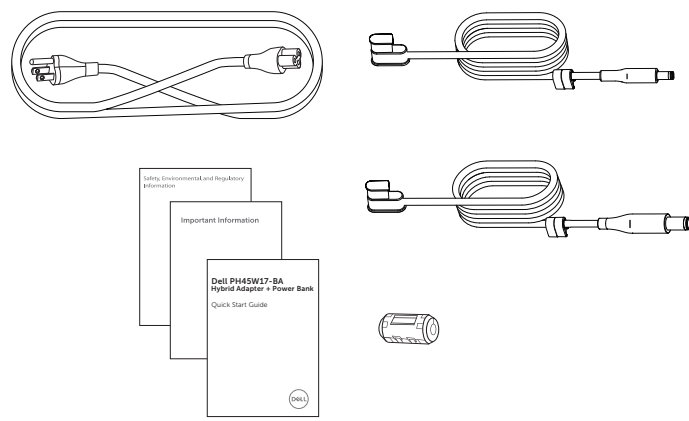
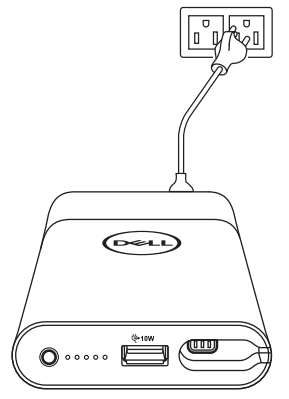

2

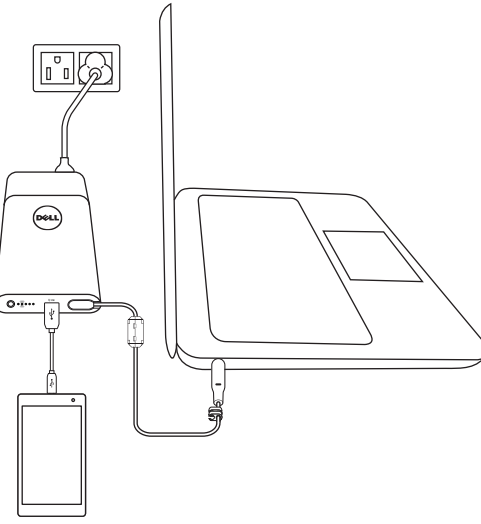

1

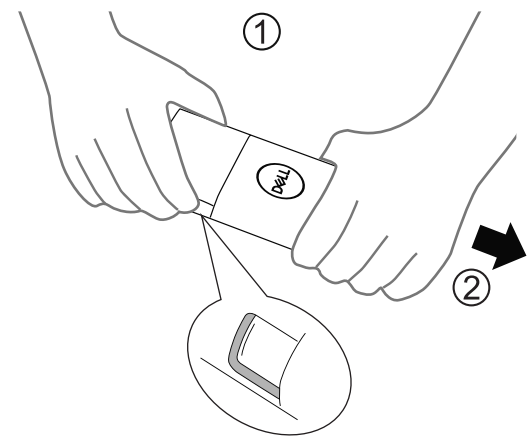

2

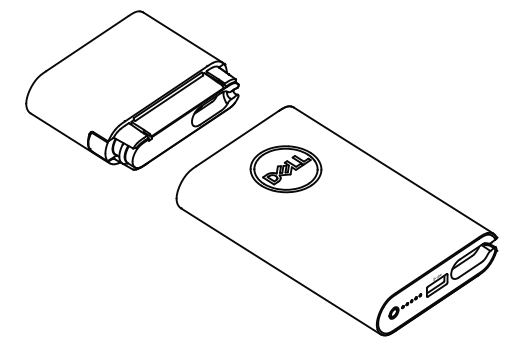

3

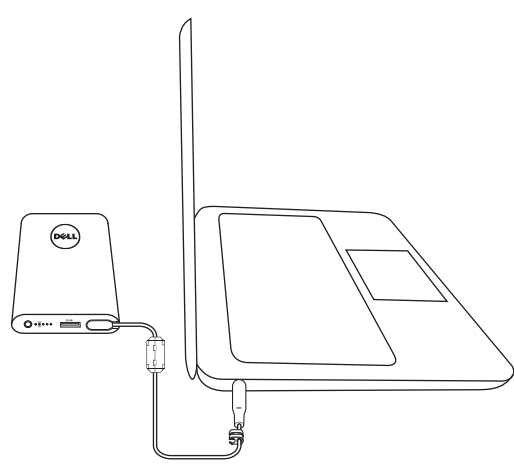

1

2

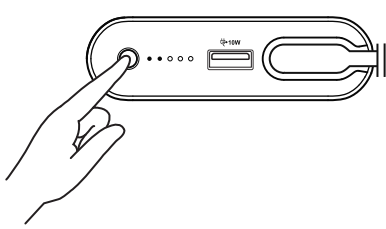

4

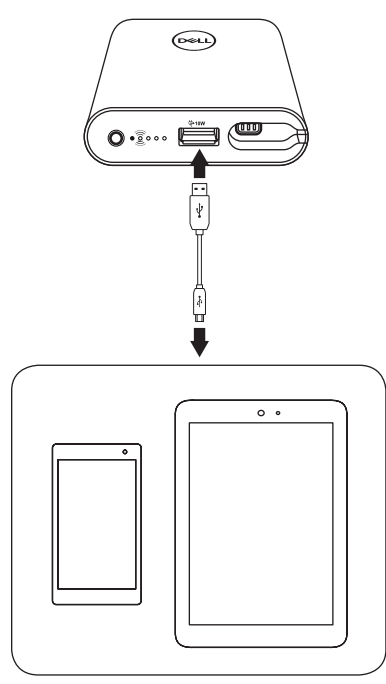

1

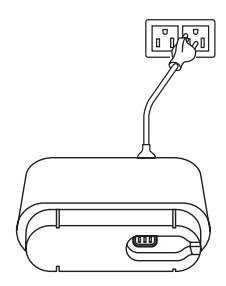

2

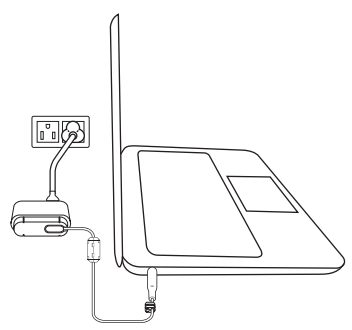

Dell.com/support  
Dell.com/support/manuals  
Dell.com/regulatory\_compliance